

SHARP®

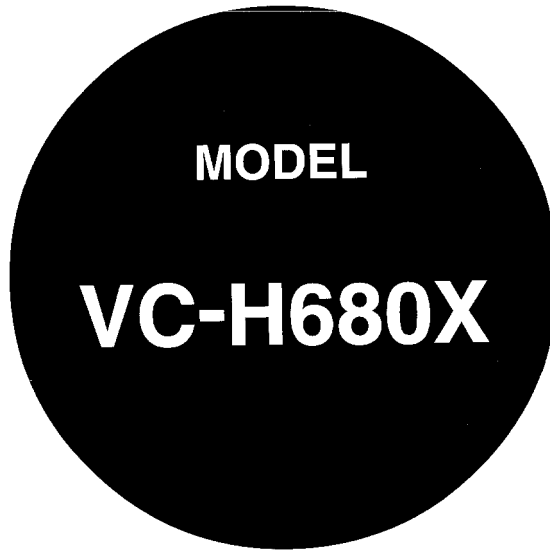

VIDEO CASSETTE RECORDER OPERATION MANUAL

Please read this operation manual carefully
before using the VCR.

G-CODE®

General
Information

Sett

Up

Basic
Operations

Rec

func

Special
Functions

Helpful
Hints

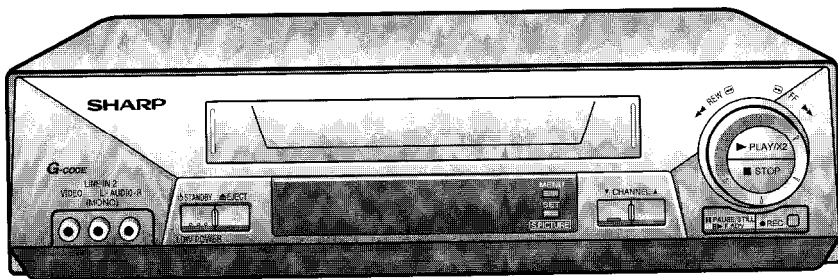

MID & SHUTTLE

VHS HQ HIGH QUALITY
PAL NTSC

CONTENTS



GENERAL INFORMATION

IMPORTANT SAFEGUARDS AND PRECAUTIONS	3
Features	4
Accessories	4
LOW POWER Feature	5
Major Components of Your VCR	6
Remote Control	7
• Inserting the Batteries	
Using the Remote Control for TV Operation	8



SETTING UP

Connections	9
Connecting to a Stereo TV	9
Connecting to TV and Audio Equipment	9
Adjusting the Video Channel	10
Menu Screen	11
OSD (On Screen Display)	11
• How to Display Indicators	
Setting the Language	12
Setting the Clock	13
Setting the Channels	14
Channel Skip/Canceling Skip	16
Mode Selection	17



BASIC OPERATIONS

Playback	18
• Inserting a Video Cassette	
• Playback	
• Video Search	
• Fast Forwarding and Rewinding	
• Shuttle System	
• Slow Motion Playback (with the Remote Control)	
• Still Picture and Frame Advance	
• Double Speed Playback	
• Colour Mode	
• NTSC Tape Play Back on PAL TV	
• *Auto Tracking Control System	
• Auto Head Cleaning System	
• Quick Start with Full Loading Mechanism	
• Auto Rental Mode	
• Blue Back	
• Full Auto Playback	
• Playback of Hi-Fi Recorded Tapes	
• *Audio Output Mode	
• Adjusting Hi-Fi Audio Tracking	



RECORDING

Recording a TV Programme	23
• Cassette Erase Protection	
• Recording a TV Programme	
• To Watch Another TV Programme While Recording	
Recording Hi-Fi Stereo Sound	24
NTSC AV Recording	25
Simple Recording Timer	26
Programming the Timer with G-CODE	27
Recording with the Timer	29
• *Confirming Timer Programmes	
• Cancelling Timer Programmes	
Intelligent Timer Recording (JUST REC)	32



SPECIAL FUNCTIONS

New Sharp Super Picture	33
Zero-Back Function	33
DPSS (Digital Programme Search System)	33
Auto Repeat	34
Skip Search	34
Instant Replay	34
New Child-Proof Lock	35
VCR Display	36
Tape Remaining Display	37
Editing from a Camcorder to Your VCR	38



HELPFUL HINTS

Specifications	38
Before Calling for Service	39

IMPORTANT SAFEGUARDS AND PRECAUTIONS

General Information

CAUTION

BEFORE OPERATING YOUR NEW VCR, PLEASE CAREFULLY READ THIS OPERATION MANUAL AND THEN SAVE IT FOR FUTURE REFERENCE AS IT WILL BE USEFUL IF YOU HAVE ANY PROBLEMS OPERATING YOUR VCR IN THE FUTURE.

Location and Handling

1. Air vents are provided in the VCR cabinet to prevent excessive temperatures inside the unit. Do not place your VCR in closed spaces, cover it, or otherwise block the vents.
2. Do not place the VCR in direct sunlight, or near heat sources
3. Keep the VCR and tapes away from strong magnetic objects.
4. Do not insert or drop anything into the VCR through the air vents or cassette compartment as this could cause serious damage, possibly resulting in fire.
5. Do not place any object containing water or other liquids on the VCR. In the event that liquid should enter the cabinet, unplug the VCR immediately and contact the retailer or a service centre approved by Sharp immediately.
6. Do not remove the VCR cabinet. Touching parts inside the cabinet could result in electric shock and/or damage to the VCR. For service and adjustment inside the cabinet, call a qualified dealer or service centre approved by Sharp.
7. The use of head cleaning tapes is not recommended as they may cause damage to your machine.

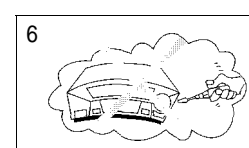
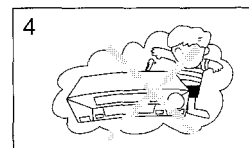
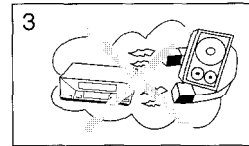
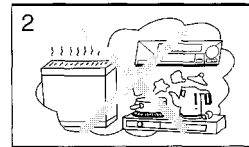
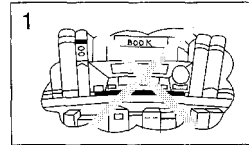

Caution-Prevent Condensation

When moving the VCR from a cold place to a warm one, condensation (dew) is likely to form on the VCR drum and heads.

If you try to play back or record in these circumstances, the videotape and VCR may be damaged.

To prevent this, turn the power switch on and wait for a few hours for the VCR to warm up and dry before attempting playback or recording.

This is particularly important before loading a cassette for the first time after purchasing the VCR.

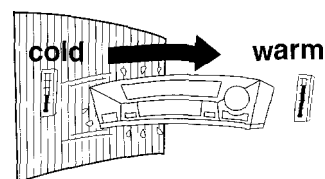



IMPORTANT SAFEGUARDS AND PRECAUTIONS

Service

Do not attempt to service this VCR yourself. Please carry out the user checks on page 39. If you still experience a problem, contact your dealer or nearest Sharp service facility.

Others

Copyright may exist in material you wish to record. Copying such material without permission of the relevant licensee(s) or owner(s) of the copyright is prohibited by law. SHARP is not in a position to authorize the recording of copyright works and nothing in this manual should be read or implied as giving that authority.



Features

- **VHS Hi-Fi Stereo Sound System/IGR System**
- **Instant Video Programme System**
- **MID-Drive (New Centre-Mounted Mechanism)**
- **HQ (High Quality) Circuitry**
- **Multi Language On Screen Display (English, French, Spanish, Chinese)**
- **New Sharp Super Picture** — Enhances picture quality during playback.
- **OSD (On Screen Display) with Menu Screen Guidance**
- **DPSS (Digital Programme Search System)**
- **Quick Start with Full Loading Mechanism**
- **365-Day, 8-Programme Timer (Daily/Weekly Programmable)**
- **Auto Channel Tuning**
- **48-Channel Preset PLL Frequency Synthesized Tuner**
- **Built-in Shuttle Control**
- **LOW POWER feature**
- **Built-in Front AV Jacks/Video Input Terminals**
- **60-minute Timer Memory Backup** -Timer settings, etc. remain in memory after power interruptions of up to 60 minutes.
- **380-times High Speed Rewinding Function** — Enhances rewinding at a speed 380 times faster than the LP mode recording/playback speed (only with an E-180 tape).
- **NTSC Recording** — NTSC signals can be recorded through the AV input terminals.

* **G-CODE** is a registered trademark of Gemstar Development Corporation The **G-CODE** system is manufactured under license from Gemstar Development Corporation

POWER SUPPLY:

The voltage supply of this VCR is AC 240 V, 50 Hz.

CASSETTE TAPE:

Use only video cassette tapes that carry the **VHS** or **VHS** mark



Accessories

Be sure that the following accessories are all included with your VCR.

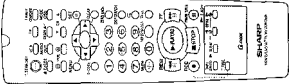
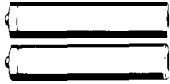
 <p>Coaxial cable (TV-VCR cable)</p>	 <p>Remote control unit</p>	 <p>Two (R6 UM/SUM-3 or AA) batteries for the remote control unit</p>
---	--	---



LOW POWER Feature

This model is equipped with a LOW POWER feature to save energy when the VCR is not in use.

STANDBY/LOW POWER button
Clock keeps time regardless of this button.

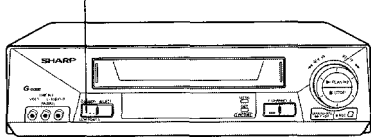

This VCR is not equipped with a mains power switch. Accordingly, nominal current to drive the clock is drawn at all times when the AC power cord is plugged into a wall socket. If the VCR is not to be used for an extended period, be sure to unplug the cord.

1. Definitions of POWER modes

POWER ON mode	<ul style="list-style-type: none"> • VCR in operation or ready for operation. • VCR display is on.
POWER STANDBY mode	<ul style="list-style-type: none"> • VCR in standby mode. • VCR display is on.
LOW POWER mode	<ul style="list-style-type: none"> • VCR display is off, but clock continues to keep time. • Noise may appear on the screen when watching TV in this mode. If this occurs, switch to POWER STANDBY mode. • This mode cannot be used when the programmable timer is set to TIMER ON.

2. In POWER ON mode

Each time **STANDBY/LOW POWER** on the VCR or **STANDBY** on the remote control is pressed, the POWER MODE changes as shown below.

(Current)

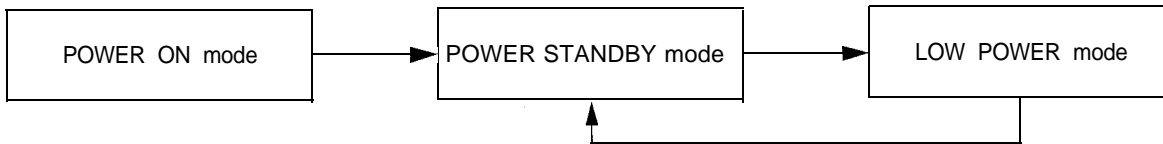

NOTE

- LOW POWER mode cannot be used when the programmable timer is set to TIMER ON.

3. Switching from POWER STANDBY or LOW POWER mode to POWER ON mode.

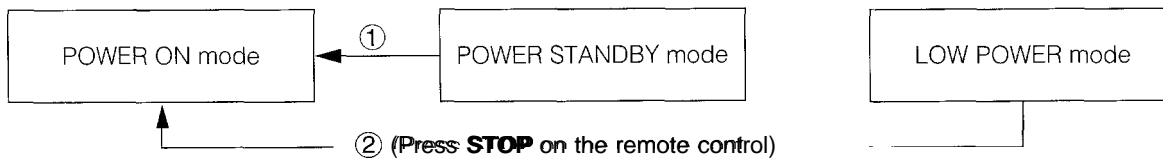

- 1 Press **STOP** on the VCR or the remote control to switch from POWER STANDBY mode to POWER ON mode.
- 2 Press **STOP** on the remote control to switch from LOW POWER mode to POWER ON mode.
- 3 By pressing one of the tape operation buttons on the remote control (**PLAY**, **REW**, **FF**, etc.) with a video tape in the VCR, the mode will automatically switch to POWER ON and the tape operation will begin.

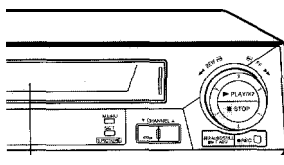

Video tape must be loaded

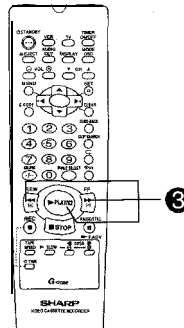



Major Components of Your VCR

Front

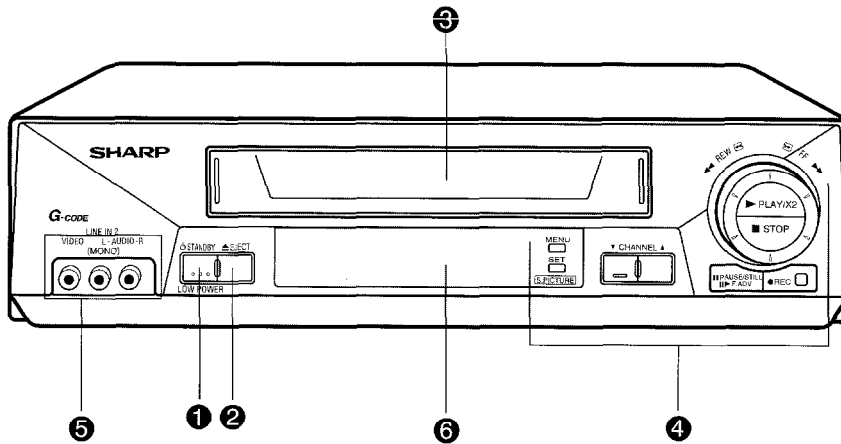

- ① STANDBY/LOW POWER button (See page 5.)
- ② EJECT button
- ③ Cassette compartment (See Playback, Recording.)
- ④ Basic function controls (See Playback, Recording.)
Channel tuning controls (See Setting the Channels.)
- ⑤ Front AV jack (LINE IN 2: VIDEO, AUDIO-L/R)
- ⑥ VCR Display (explained throughout the operation instructions)



The meaning of the main indicators is shown below. (This list does not include all indicators.)

	Cassette-In Indicator	SLOW	Slow	VSR	Video Search Rewind
	Play/Double speed playback	• REC	Record (When operating mode is displayed)	VSF	Video Search Forward
	Rewind	• PAUSE	Rec Pause		New Child-Proof lock
	Fast Forward	STOP	Stop	L1/L2	LINE IN 1/2
	Still/ Frame Advance		Recording with the timer/ Simple Recording timer	36 RF	RF Output Channel
	When AC power cord is first plugged in.	●	Recording mark		

NOTE

- The display changes each time DISPLAY on the remote control is pressed. (See page 36.)
- Some of the indicators above will light up only for a couple of seconds when the VCR is set up the corresponding mode.

Rear

Connection terminals (See **Connections** on page 9.)

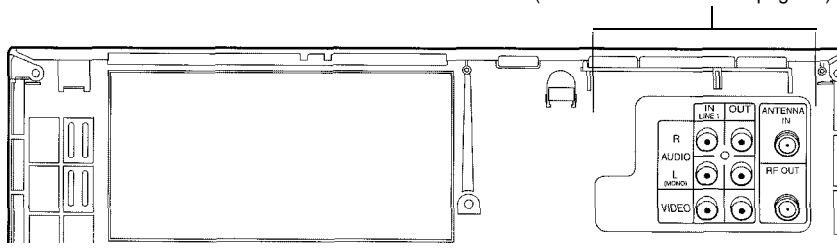



Remote Control

U 37 11 E

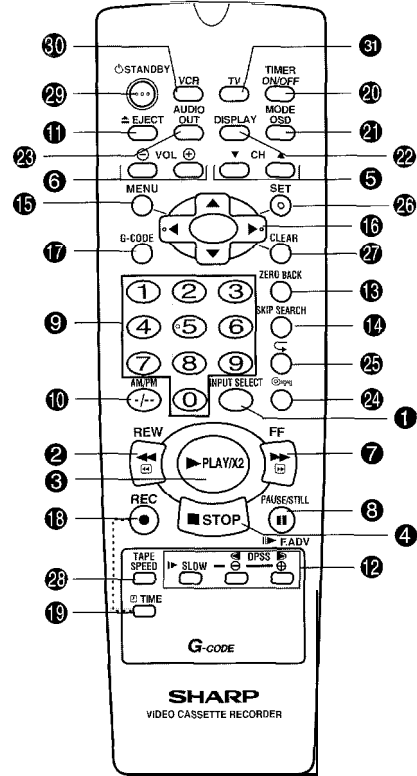

- 1 INPUT SELECT button
- 2 REW button
- 3 PLAY/x 2 button
- 4 STOP button
- 5 CHANNEL (CH) ▲ / ▼ button
- 6 VOLUME (VOL) ⊕ / ⊖ button
- 7 FF button
- 8 PAUSE/STILL (F. ADV) button
- 9 Numeric buttons
- 10 AM/PM button
- Digit select (When Inputting up to two digit numbers)

- 11 EJECT button
- 12 SLOW/@@ buttons (SLOW ⊕/⊖, DPSS ▶/◀)
- 13 ZERO BACK button
- 14 SKIP SEARCH button
- 15 MENU button
- 16 ◀/▶/▲/▼ button
- 17 G-CODE button
- 18 REC button
- 19 TIME button
- g1 TIMER ON/OFF button
- 21 MODE OSD button

- 22 DISPLAY button
- 23 AUDIO OUT button
- 24 Ⓜ button (New Child-proof Lock)
- 25 REVIEW SEARCH button
- 26 SET button
- 27 CLEAR button
- 28 TAPE SPEED button
- 29 STANDBY button
- 30 VCR button
- 31 TV button

Inserting the Batteries

First, install the batteries properly. Fit two R6 (UM/SUM-3, AA) 1.5 volt batteries (included) or equivalent. If the remote control stops working, insert new batteries.

Ensure the batteries are inserted correctly, matching the polarities (+/-) indicated in the remote control.

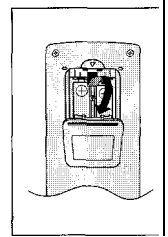

NOTE

- Do not subject the remote control to shock, water or excessive humidity.
- The remote control may not function if the VCR sensor is in direct sunlight or any other strong light.
- Incorrect use of batteries may cause them to leak or burst. Read the battery warnings and use the batteries properly.
- Do not mix old and new batteries, or mix brands in use.
- Remove the batteries if you will not use the remote control for an extended period of time.

Using the Remote Control for TV Operation'

The provided remote control can operate the basic functions of your television. In addition to most Sharp televisions, other manufacturers' televisions listed below can also be controlled by setting the remote control to the corresponding TV brand. The remote control's default brand is "SHARP", which enables control of most Sharp televisions. When you replace the batteries in the remote control, the control's TV brand setting will be reset to SHARP.

Setting the TV Brand

- 1 Turn on your TV.
- 2 From the table below select the button which corresponds with the brand of your TV. Simultaneously press both this button and **STANDBY**. Hold down for about five seconds.

When setting is complete, the remote control will send a "power off" signal (⏻) to the TV, and it should turn off.

NOTE

- If the TV does not turn off in step 2, repeat the step 2 setting procedure and select the button for a different brand.

TV BRAND NAME	Corresponding button	TV BRAND NAME	Corresponding button
SHARP	1	GRAETZ	7
PHILIPS	2	LUXOR	7
THOMSON	3 or 4	SALORA	7
TELEFUNKEN	3 or 4	SELECO	7
NORDMEND	3 or 4	SONY	8
BRANDT	3 or 4	TOSHIBA	9
SABA	3 or 4	PANASONIC	0 or /--
TELAVIA	3 or 4	SANYO	⊖ VOL
GRUNDIG	5	HITACHI	INPUT SELECT
BLAUPUNKT	5	MITSUBISHI	▼ CH
FERGUSON	6	JVC	CH ▲
ITT NOKIA	7		

(For example)

TV brand: SHARP
(Corresponding button is "1")

Press these buttons simultaneously and hold down for about five seconds.

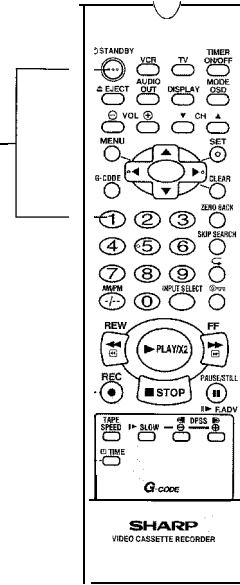

TV Functions to be Controlled

Switch to TV control mode.

- Press TV to select the TV control mode.



Return to VCR control mode.

- Press VCR to select the VCR control mode.

TV function control

- 1 Press TV to select the TV control mode.
- 2 Use the following buttons on your remote control to operate your TV set.

TV function

- *TV POWER (⏻)
- TV CHANNEL UP/DOWN
- *TV VOLUME UP/DOWN
- INPUT SELECT button (TV-AV selector)

- 3 Press VCR to return to the VCR control mode.

NOTE

- When you replace the batteries in the remote control, if your television is not a Sharp model you must reset the TV brand.
- If MENU, PLAY, STOP, FF or REW are pressed in the TV control mode, the remote control will return to VCR control mode.

IMPORTANT NOTE:

Although the provided remote control unit is compatible with most SHARP televisions, as well as many TV models manufactured by others, it is possible that the provided remote control will not work with your TV, or will control only some of the functions.

If the button listed in the table does not work with your TV set, you may want to try another; occasionally, models vary within a brand.

Consequently, Sharp's warranty does not cover all of the models under the brands listed in the table.



Connections

1 Disconnecting TV Cable

Disconnect the aerial cable from the back of your TV set.

2 Connecting Aerial Cable to VCR

Connect the aerial cable to the **ANTENNA IN** terminal of your VCR.

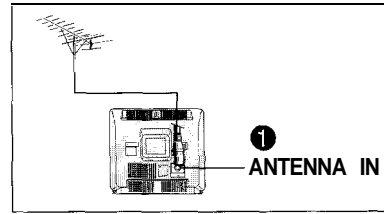

Setting Up

3 Connecting VCR to TV

Connect the supplied coaxial cable to the **RF OUT** terminal of the VCR. Plug the other end into your TV's **ANTENNA IN** terminal.

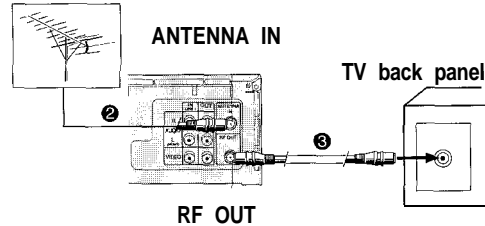

Connecting to a Stereo TV

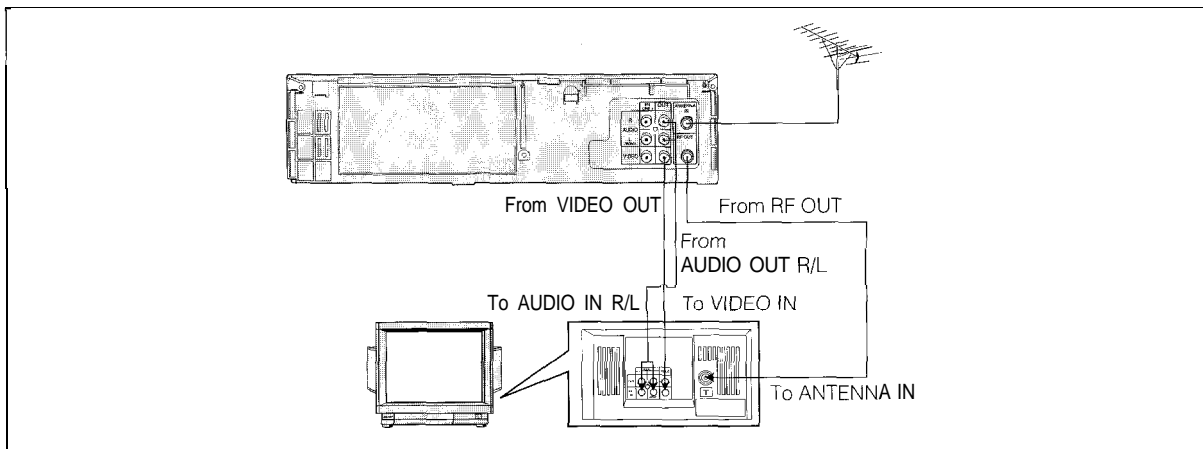

NOTE

- Stereo sound output is only possible using the AUDIO OUT terminals. Sound from the radio frequency converter (RF OUT) is mono only.
- The power cord should not be plugged into the power outlet until the above connections have been completed.
- If TV reception is weak, use a TV signal booster (not supplied).



Connecting to TV and Audio Equipment

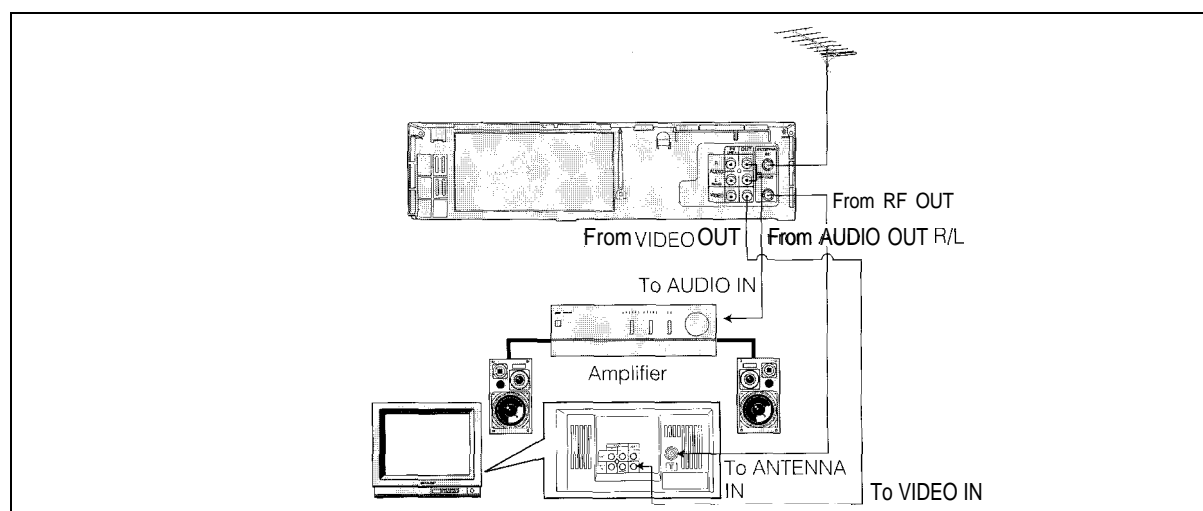

Adjusting the Video Channel

To view the output of your VCR on the television screen, you must select an unused channel on your TV and tune it to the output of your VCR (factory preset to UHF channel 37).

- ❶ Turn on the TV, select the AV channel or an unused channel on the TV, and turn on the power on the VCR. (See page 5, item 3.)
- ❷ Load a prerecorded tape (not supplied) into the VCR.
- ❸ If the erasure protection tab on the tape is removed, the VCR will automatically play back the tape. Otherwise press **PLAY** × 2.
- ❹ Tune the selected channel on the TV until the picture from the VCR is displayed on the TV screen. (This TV channel must be selected each time the VCR is used.)

• If picture interference appears on the TV screen in step ❹ above, you can change the video channel (RF output channel from the VCR) with the following procedure. (If UHF channel 37 is an active broadcast channel in your area, manually select a different channel (UHF 28 to UHF 69) (see below) and then retune your TV as above.)

- (A) Press **STANDBY (LOW POWER)** on the VCR, or **STANDBY** on the remote control. The VCR enters POWER STANDBY mode. (See page 5, item 2.)
- (B) Keep pressing **MENU** for more than two seconds to light up the **RF** on the VCR display.
- (C) Press **CHANNEL** ▼/▲ on the VCR or ▲/▼ button of  on the remote control to manually select an unused channel for use as the video channel, then press **SET**.
- (D) Repeat steps ❶ to ❹ above using the newly selected video channel.

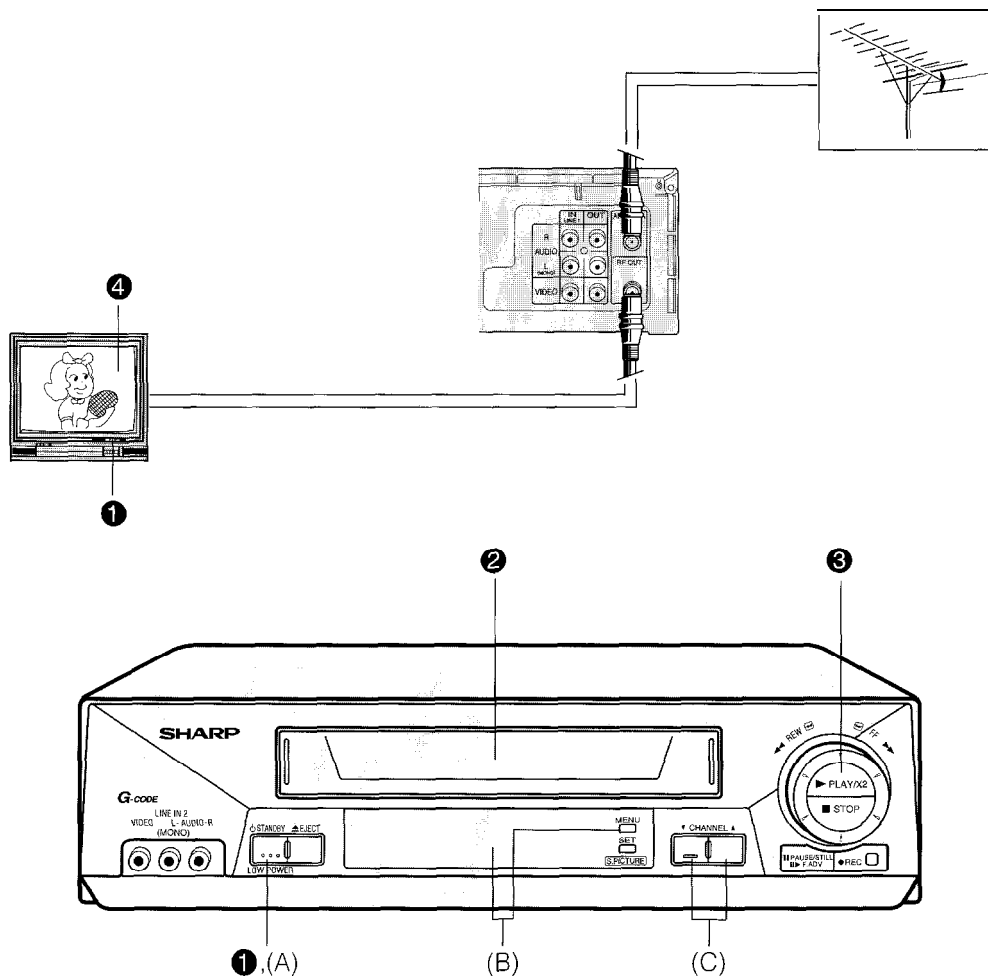



Menu Screen

MENU screen is a home screen used to select various screen functions. A sub-menu will appear once you select an item for the menu.

- 1 Turn on your TV and select the video channel.
- 2 Turn on the VCR. (See page 5, item 3.)
- 3 Press **MENU** to display the MENU screen.
- 4 Select the item you want by pressing **▲** or **▼** on the remote control. Refer to the pages listed below for details on each item.

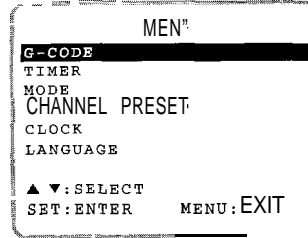

The following 6 items can be set by using the On Screen Display (OSD).

- 1: G-CODE Setting a G-CODE timer recording. (See page 27)
- 2: TIMER Setting a timer recording (and checking it). (See page 29 for the setting procedure.)
- 3: MODE VCR operating conditions are set according to the broadcast reception and tape playback conditions. (See page 17.)
- 4: CHANNEL PRESET Setting the channels. (See page 14.)
- 5: CLOCK Setting the present time. (See page 13.)
- 6: LANGUAGE Selection of language to be used for the On Screen Display. (See page 12.)

- 5 Press **SET**. The screen changes to the item which you have selected
- 6 To cancel the MENU screen, press **MENU**.



OSD (On Screen Display)

The tape counter and VCR mode can be shown on the screen while you are playing back a tape or watching a broadcast on the video channel.

Display example

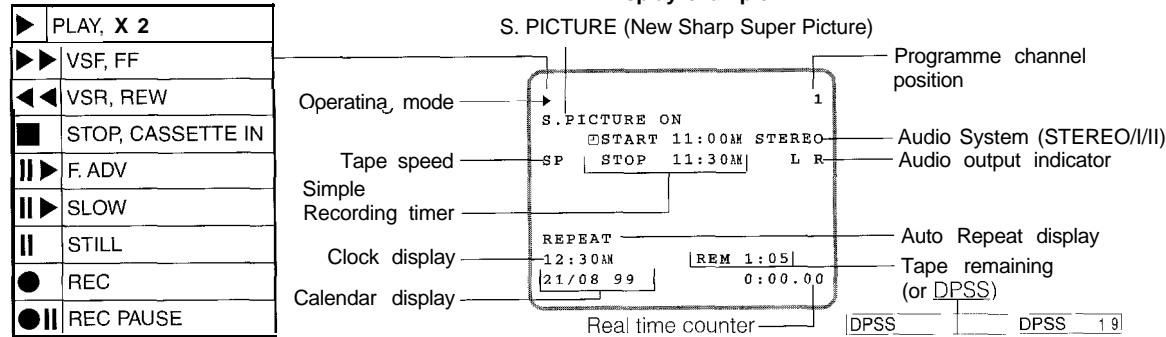

NOTE

- If the clock is not set, the time and date will not be displayed

How to Display Indicators

- 1 Turn on your TV and select the video channel.
- 2 Turn on the VCR. Mode indicators are displayed in the AUTO display screen.
- 3 Each time **MODE OSD** is pressed, the screen changes as follows:

- 1 AUTO Display → 2 FULL Display → 3 COUNTER Display → 4 Display off

AUTO Display

When each of the operation buttons, numeric button, or **CHANNEL ▲/▼ (CH ▲/▼)** is pressed, the current mode or the number of the channel will be displayed in the upper section of the TV screen for about 3 seconds.

NOTE

- When you record a video signal output from this VCR on another VCR, press **MODE OSD** to select Display Off. (If the mode indicator is displayed on the screen, it is also recorded on the tape.)



Setting the Language

PREPARATION

- Select the video channel on your TV and turn power ON the VCR. (See page 5, item 3.)

NOTE

- Language setting screen will appear when the VCR is used for the first time. If the power has been disconnected, clock setting screen will appear first.

- While in MENU, the ▲/▼/◀/▶ buttons on the remote control operates the following functions (same functions on the VCR):
 - ▲ → CHANNEL ▲
 - ▼ → ▼ CHANNEL
 - ◀ → REW (Shuttle Ring)
 - ▶ → FF (Shuttle Ring)

initial Setting of Language

	<p>① Select the language with ▲/▼ and press SET Ex.: <i>ENGLISH</i></p> <p>NOTE</p> <ul style="list-style-type: none"> • Refer to page 13 to set the clock.
--	--

Changing Language

- If the language has already been set previously and you want to change it, follow the steps below.

<p>MENU</p>	<p>① Press MENU. Select item "LANGUAGE" with ▲/▼ and press SET,</p>
	<p>② Select the language with ▲/▼ and press SET Ex.: <i>ENGLISH</i></p>
<p>MENU</p>	<p>③ To return to the normal screen, press MENU</p>



Setting the Clock

When you use the VCR for the first time or after a power failure of more than 60 minutes the clock will be reset. Apply power to the unit to power on (see page 5, item 3). Then perform the following procedure.

PREPARATION

*Select the video channel on your TV and turn on the VCR. (See page 5, item 3.)

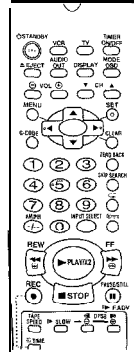

initial Setting of Clock

1 First set the language (refer to page 12). Then press SET.	
	2 Select whether the clock should show 12-hour AM/PM time or 24-hour time by pressing ▲/▼, and then press SET. <i>Ex.: 12H</i> NOTE <ul style="list-style-type: none"> • "24H" 24-hour display. • "12H" 12-hour AM/PM display. • 12H (AM/PM) mode is preset at the factory.
	3 Set the present time with the numeric buttons or ▲/▼ on the remote control. (First set the 'hour' digits and then the 'minute'. If there is only one 'hour' or one 'minute' digit, enter a 0 first.) Set AM or PM, using AM/PM (12 hour) and then press ►. <i>Ex.: 10:28AM</i> NOTE <ul style="list-style-type: none"> • If 12H mode was selected, then set the AM/PM indicator.
	4 Set the date with the numeric buttons or ▲/▼ on the remote control. (First set the 'day' digits and then the 'month'. If there is only one 'day' or one 'month' digit, enter a 0 first.) and then press ►. <i>Ex.: Dec. 15 (15/12)</i>
	5 Set the year digits with the numeric buttons or ▲/▼ on the remote control. (Enter the last two digits of the year.) <i>Ex.: 99</i>
	6 Press SET.

Changing the Clock Setting

	1 Press MENU. Select item "CLOCK" with ▲/▼ and press SET. 2-5 Follow steps 2 through 5 above and step 6 below.
	6 Press SET. To return to the normal screen, press MENU



Setting the Channels

7

Your VCR can receive VHF channels 0 to 12, and UHF channels 28 to 69. Your VCR has 48 programmable channel positions, each of which can be set to any of the above broadcast channels. The channel positions have been preset at the factory as shown below.

Position	Preset TV Channel	Position	Preset TV Channel
0	Skipped channel	8	Skipped channel
1	Skipped channel	9	VHF 9
2	VHF 2	10	VHF 10
3	Skipped channel	11-27	Skipped channels
4	Skipped channel	28	UHF 28
5	Skipped channel	29-46	Skipped channels
6	Skipped channel		
7	VHF 7	47	Skipped channel

NOTE

- Use the ▲ / ▼ / ◀ / ▶ buttons on the remote control to set the OSD.
- Channel position numbers 0, 1, 3 to 6, 8, 11 to 27, and 29 to 47 have been factory set to be skipped when **CHANNEL ▲** or **▼** (CH ▲ or ▼) is used.
- If the picture is not clear, if you want a different channel from the one preset or if you wish to reset a skipped channel, reset the channel as follows

AUTO TUNING

PREPARATION

- Select the video channel on your TV and turn on the VCR. (See page 5, item 3.)

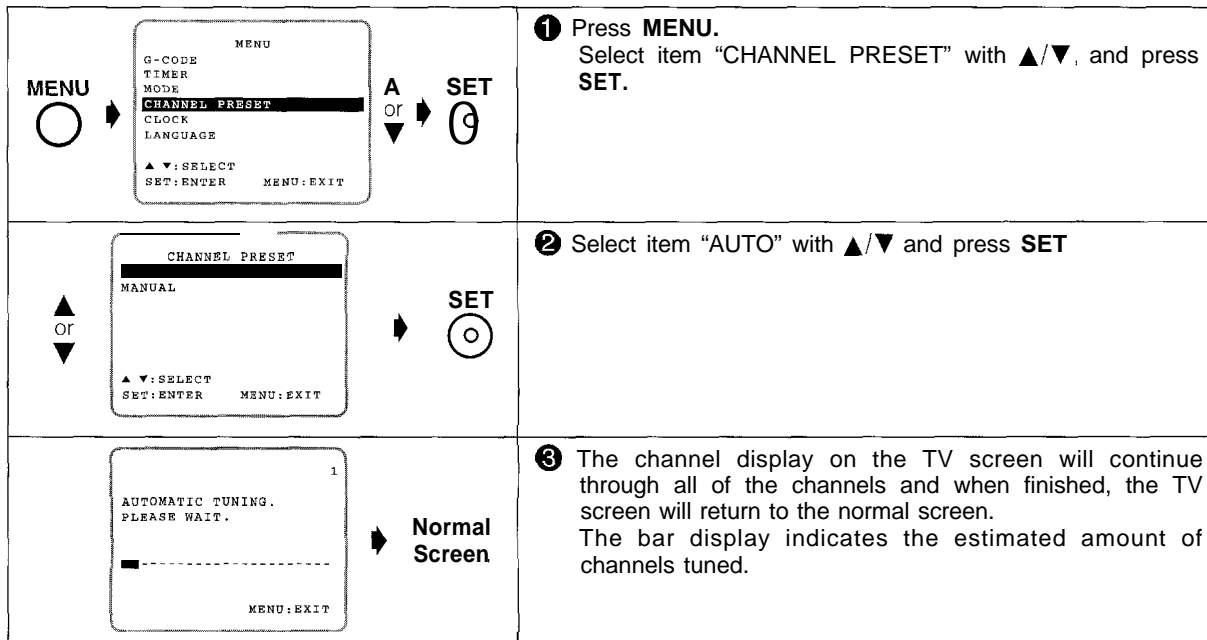

NOTE

- If additional unwanted channels were found, refer to page 16 to skip unwanted channels
- If some channels were unable to be found, refer to **Manual Tuning** on page 15.











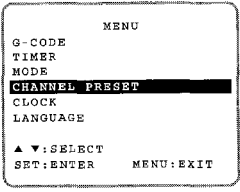
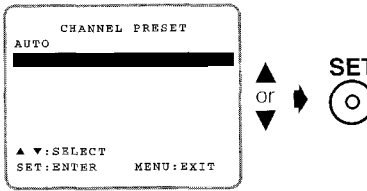

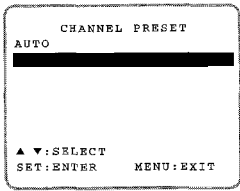

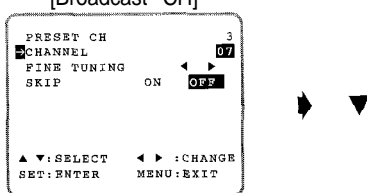
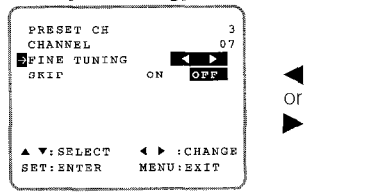

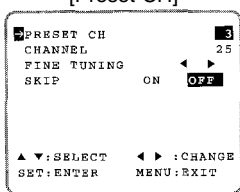

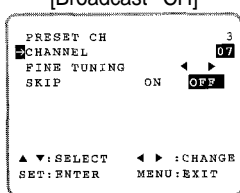

MANUAL TUNING

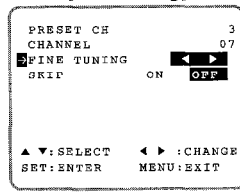
PREPARATION

*Select the video channel on your TV and turn on the VCR. (See page 5, item 3.)

Example: Tuning Broadcast TV Channel 7 to preset Channel 3.

   	<p>1 Press MENU. Select item "CHANNEL PRESET" with ▲/▼ and press SET.</p>
  	<p>2 Select item "MANUAL" with ▲ or ▼ and press SET.</p>
<p>Numeric buttons</p>     	<p>3 Select the preset channel position number with the numeric buttons or ◀/▶ and then press ▼.</p>
<p>Numeric buttons</p>     	<p>4 Press the numeric buttons or ◀/▶ until you see the desired broadcast channel on your TV, and then press ▼.</p> <p>NOTE ▶</p> <ul style="list-style-type: none"> When Digit select is set to two digit input, and the channel number is only one digit, enter "0" first.
  	<p>5 For fine tuning, press ◀ or ▶ until the broadcast channel comes in clearly on your TV.</p>
  <p>Next Screen</p>	<p>6 Press SET. If you wish to preset more channels, repeat steps 3 through 5.</p>
  <p>Normal Screen</p>	<p>7 To return to the normal screen, press MENU.</p>

NOTE ▶

• Numeric buttons on the remote control can also be used to select channel numbers. Press +/- to switch between one and two digit numbers for step **3**.







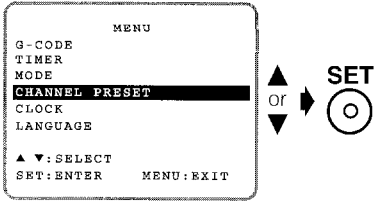

Channel Skip/Cancelling Skip

Channel skip

If there are channel positions that are not preset, you can skip them with the following procedure.

PREPARATION





- Select the video channel on your TV and turn on the VCR (See page 5, item 3)

Example: Skip channel position 12.	
 → 	1 Press MENU . Select item "CHANNEL PRESET" with ▲/▼ and press SET .
 or 	2 Select item "MANUAL" with ▲/▼ and press SET .
 or (Numeric buttons)	3 Set the channel position you wish to skip with ◀/▶ (or numeric) buttons. Ex.: 12
 or	4 Select SKIP setting mode with ▲ or ▼.
 or 	5 Press ◀ or ▶ to select SKIP ON and press SET .
	6 If you wish to set more channels to be skipped, repeat steps 3 through 5 .
 → Normal Screen	7 To return to the normal screen, press MENU .

Cancelling skip

PREPARATION

- Select the video channel on your TV. And turn on the VCR. (See page 5, item 3.)

Example: Reset channel position 12.	
<ul style="list-style-type: none"> Follow the same procedures 1, 2 in Channel skip, and then the procedures 3–7 below. 	
 or (Numeric buttons)	3 Select the channel position you wish to unskip with the numeric or ◀/▶ buttons. Ex: 12
 or	4 Select SKIP setting mode by pressing ▲ or ▼.
 or 	5 Press ◀ or ▶ to select SKIP OFF and press SET .
	6 If you wish to unskip more channels, repeat steps 3 through 5 .
 → Normal Screen	7 To return to the normal screen, press MENU .



Mode Selection

You can set the basic functions listed in the table below on the **MODE** selection screen.

PREPARATION

- Turn on your TV and select the video channel and turn on the VCR. (See page 5, item 3.)

	<ol style="list-style-type: none"> 1 Press MENU. 2 Select the MODE selection mode with ▲/▼, and then press SET.
<p>[Colour]</p>	<ol style="list-style-type: none"> 3 Select the COLOUR mode by pressing ◀/▶, and then press ▼. (For details, see Colour Mode on page 20.) AUTO Usually select AUTO mode. PAL Strict PAL colour mode. NTSC Strict NTSC colour mode.
<p>[NTSC mode]</p>	<ol style="list-style-type: none"> 4 Select the NTSC mode with the ◀/▶ buttons and press the ▼ button. NTSC 3.58 When using NTSC 3.58 TV system format. (Input signal: NTSC 3.58) NTSC 4.43 When using NTSC 4.43 TV system format. (Input signal: NTSC 4.43) PAL TV ... When using PAL TV system format. (Input signal: NTSC 4.43)
<p>[Blue Back]</p>	<ol style="list-style-type: none"> 5 Select the BLUE BACK mode by pressing ◀/▶, and then press ▼. AUTO Usually select AUTO. A blue screen will appear when your VCR receives no TV signal or an unrecorded tape is played back. OFF Select OFF if the screen turns blue due to weak TV signal reception, or playback of a poorly recorded tape.
<p>[Auto Rental]</p>	<ol style="list-style-type: none"> 6 Select the AUTO RENTAL mode by pressing ◀/▶, and then press ▼. (For details, see Auto Rental Mode on page 21.)
<p>[Repeat]</p>	<ol style="list-style-type: none"> 7 Select the REPEAT mode by pressing ◀/▶, and then press ▼. (For details, see Auto Repeat on page 34.)
<p>[Just REC]</p>	<ol style="list-style-type: none"> 8 Select the JUST REC mode by pressing ◀/▶, and then press ▼. (For details, see Intelligent Timer Recording (JUST REC) on page 32.)
	<ol style="list-style-type: none"> 9 Press SET. To return to the normal screen, press MENU.

Playback

Inserting a Video Cassette

Gently insert the video cassette into the cassette compartment. The VCR turns on automatically. If the cassette is inserted incorrectly, the loading system will not function. Do not force the cassette into the VCR. When the cassette has been properly loaded, "00" appears on the VCR display.

To remove the cassette, press **EJECT** during stop mode.

Playback

PREPARATION

- Turn on your TV and select the video channel.

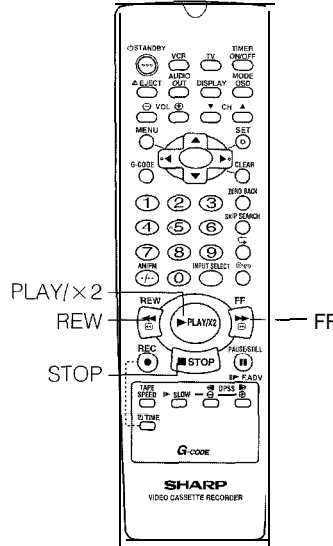
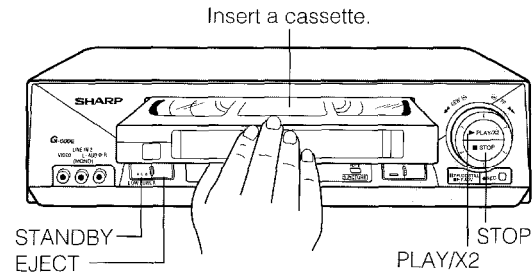

- 1 Turn on the VCR. (See page 5, item 3.)
- 2 Insert a cassette.
- 3 Press **PLAY/x2**. (The auto tracking control system engages and "▶" flashes on the TV screen for a few seconds.)

- 4 To stop playback, press **STOP**. (If the tape reaches its end, the VCR will automatically rewind the tape to the beginning, eject the cassette, and turn into POWER STANDBY mode.)

NOTE

- NTSC tapes recorded in Hi-Fi and EP mode may appear distorted during playback. This does not indicate a malfunction. The tracking function can be used to slightly enhance the picture quality.

Video Search

Use the following procedure to quickly find the section you want, while viewing the picture.

- 1 During playback, press **FF** for forward video search, or **REW** for reverse search.

		Faster Video Search	Slower Video Search
PAL TAPE	SP/LP	×7	×3
	EP	×15	×5
NTSC TAPE	SP/LP	×5	×3
	EP	×15	×5

There are 2 search speeds in each direction. The VCR switches between them each time the button is pressed.

- 2 Press **PLAY/x2** to resume normal playback.

NOTE

- During video search of a tape recorded in the LP mode, the upper part of the picture may be skewed to one side.

Fast Forwarding and Rewinding

- 1 To move through the cassette faster, press **STOP** and then press **FF** or **REW** to fast forward or rewind the cassette. (The picture cannot be viewed in this mode.)
- 2 Press **STOP** to stop fast forward or rewind.

NOTE

- If you use other than E-90/E-180 cassettes, fast forward and rewind may take somewhat longer



Shuttle System

The shuttle system lets you control all the basic playback functions using just the shuttle ring part

NOTE

- The shuttle ring does not rotate 360°.

DURING STOP MODE

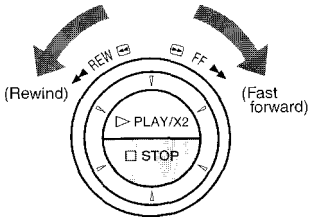

Fast Forward and Rewind

- 1 Turn the ring to the right or the left and release it. (The shuttle ring will return to centre.)
- 2 Press **STOP** to stop fast forward or rewind.

Basic Operations

DURING PLAY MODE

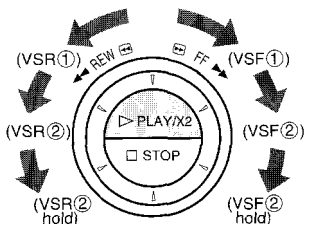

Video Search

*Turn the ring to the left or the right during playback to enter VSF (Video Search Forward), or VSR (Video Search Reverse) mode. Select from two speeds by turning the ring. Release the ring (the shuttle ring returns to centre) to return to playback.

*During playback, turning the ring all the way to the left or right locks the VCR in VSF (Video Search Forward), or VSR (Video Search Reverse) mode. Press **PLAY/X2** to return to regular playback.

TAPE SPEED

		VSFNSR (①)	VSRNSR (②)
PAL TAPE	SP/LP	x 3	x 7
	EP	x 5	x 15
NTSC TAPE	SP/LP	x 3	x 5
	EP	x 5	x 15

Slow Motion Playback (with the Remote Control)

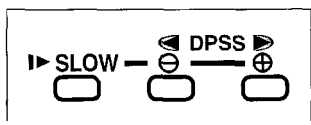

- 1 Press **SLOW** on the remote control during playback.
- 2 Press **SLOW** ⊕ or ⊖ (to the right of **SLOW**) to vary the slow motion playback speed between 1/5 and 1/30 of the normal playback speed.
- 3 Press **PLAY/X2** to resume normal playback.



Still Picture and Frame Advance

- ① Press **PAUSE/STILL (F.ADV)** during playback. This will freeze the picture on your TV.
- ② If noise bars appear on the screen during still picture, set your VCR to the slow mode and press **CHANNEL ▲/▼ (CH ▲/▼)** to make the noise disappear. Then press **PAUSE/STILL (F.ADV)** again.
- ③ If there is vertical jitter during Still Picture Playback, press **CHANNEL ▲/▼ (CH ▲/▼)** to stop the jitter.
- ④ Press **PAUSE/STILL (F.ADV)** during still mode for frame advance.
- ⑤ Press **PLAY/X2** again to resume normal playback.

Double Speed Playback

- ① Press **PLAY/X2** during playback. The tape will be played back at twice the normal speed.
- ② Press **PLAY/X2** to resume normal playback.

NOTE

- Sound is muted during video search, slow motion, still picture, frame advance, and double speed playback.
- To avoid damage to the tape, your VCR will resume normal playback after about 5 minutes of slow motion playback and still picture.
- During slow motion, still, frame advance and double speed playback with a tape recorded in the LP mode, the upper part of the picture may be skewed to one side.
- During Standard Play (SP), video search, slow motion, still picture, frame advance and double speed playback, some picture noise will remain.

Colour Mode

If a colour recording's quality is poor, the picture may turn black and white. In this event, set the COLOUR mode on the MODE selection screen to "PAL" (strict PAL colour mode) or "NTSC" (strict NTSC colour mode). Normally, the colour mode should be set to "AUTO".

(See Mode Selection on page 17.)

NOTE

- When the colour mode is set to fixed colour mode while the VCR is playing back a black and white tape or is receiving a black and white broadcast, the picture may be coloured. In this event, set the COLOUR mode on the MODE selection screen to "AUTO".

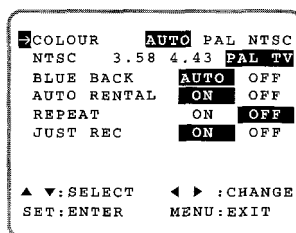

(Change with ◀ or ▶.)

Then press SET.

NTSC Tape Play Back on PAL TV

When you play back an NTSC tape on your VCR, it is possible to use a PAL or multi-system compatible TV. However, please note the following:

- The picture will shrink vertically to some degree, as shown in the diagram, but this does not indicate a malfunction in your TV or VCR.
 - If your TV does not have a V-HOLD control, the picture may roll and be unwatchable. However, if you use a TV with a V-HOLD control, you can stop the rolling by adjusting the V-HOLD control and watch the picture.
 - Horizontal noise bars may appear on the screen during special effect playback (video search, still, slow, frame advance, and double speed playback), possibly accompanied by discolouring.
- *Although NTSC tapes can be played back onto a PAL TV, those tapes cannot be dubbed by a PAL system VCR connected to the AUDIO OUT and VIDEO OUT terminals of this product. Tapes recorded in this way cannot be played back on PAL system VCRs.
- Set the COLOUR mode to AUTO. If the COLOUR mode is set to PAL, you cannot play back the tape.





Auto Tracking Control System

This function automatically adjusts the tracking to match the recorded tape. Auto tracking engages in the following cases:

*When you insert the cassette and begin playback.

- When you press **CHANNEL ▲** and **▼ (CH ▲ and ▼)** at the same time.

*When the VCR has been playing back an unrecorded section of tape, and then reaches a recorded tape segment.

When auto tracking engages, "▶" on the TV screen flashes for a few seconds.

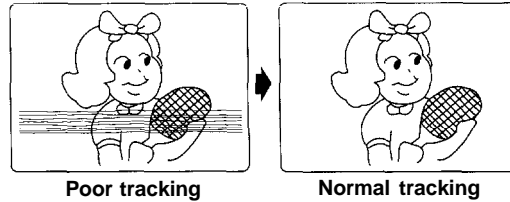

NOTE

- When a poorly recorded tape is played back, auto tracking may not operate normally. In this event, manually adjust the tracking with **CHANNEL ▲/▼ (CH ▲/▼)** to make any noise disappear.

Auto Head Cleaning System

When the tape is inserted or ejected, this system automatically cleans the drum and heads with a special roller before recording or playback begins, protecting the heads and drum from dirt and preserving beautiful picture quality.

Quick Start with Full Loading Mechanism

Your VCR has a standby function (Full Loading Mechanism) to allow immediate recording and playback.

After pressing **REC** or **PLAY/×2**, it takes about 2 seconds until recording or playback is engaged when in the standby mode.

Auto Rental Mode

(This function only works when AUTO RENTAL mode on the MODE selection screen is set to ON.)

The convenient auto rental mode lets you enjoy playback with ease. When you insert a cassette with the erasure protection tab removed (rental videos, etc.), your VCR automatically turns on the power, winds the tape forward to find the recorded section, and plays back the tape. When the tape reaches the end of recorded section, the VCR automatically rewinds the tape, ejects it and turns into POWER STANDBY mode.

NOTE

- If there is more than a 15 second unrecorded section between recorded sections, the tape will automatically stop and rewind. To watch the next recorded section, press **STOP** fast forward to that section and play the tape.
- If the erasure protection hole is covered, press **PLAY/×2** after the power turns on automatically. (Auto Rental Mode does not work.)
- If Auto Rental and Repeat (Auto Repeat) modes on the MODE selection are set to ON simultaneously, Auto Rental will not function. (if this happens, set Repeat (Auto Repeat) mode to OFF.)
- The AUTO REPEAT mode has priority over the AUTO RENTAL mode. If the AUTO REPEAT mode is set to ON and the video cassette reaches its end, the VCR will rewind the tape and play it back again without ejecting the tape or turning into POWER STANDBY mode



Blue Back

Set the BLUE BACK mode to AUTO on the MODE-selection screen. (See **Mode Selection** on page 17.) This function eliminates monitor noise and mutes sound during playback of unrecorded portions of a tape, and when receiving a non-broadcasting channel. A blue screen will also appear if the VCR is set to the Auxiliary input (LINE IN) mode but no video signal is fed to the VCR. (The BLUE BACK mode is set to AUTO at the factory.)

NOTE

- Blue Back does not function during still picture, variable slow motion and video search.
- Blue Back may not function properly if the broadcast signal is too strong or too weak.
- Blue Back cannot be recorded.
- If the antenna signal is weak while recording a TV programme, or if the input signal is weak while tape dubbing, the monitor screen may turn blue back since the unit may not recognize whether or not a proper signal is being received. In this event, set the BLUE BACK mode to OFF.

Full Auto Playback

(This function only works when AUTO RENTAL mode on the MODE selection screen is set to OFF.)

Full Auto Playback lets you enjoy playback with ease. When you insert a cassette with the erasure protection tab removed, your VCR automatically turns on the power and plays back the tape. When the tape reaches its end, the VCR automatically rewinds the tape, ejects it and turns into POWER STANDBY mode.

NOTE

- If the erasure protection hole is covered, press **PLAY/x2** after the power turns on automatically.

Playback of Hi-Fi Recorded Tapes

This VCR will play back both video and audio-only tapes recorded in the Hi-Fi mode.

NOTE

- Stereo sound output is only possible using the AUDIO OUT terminals. Sound from the radio frequency converter (RF OUT) is mono only. A blue screen will appear if audio-only Hi-Fi tapes are played back.

Audio Output Mode

The audio output mode is controlled by **AUDIO OUT** on the remote control. The VCR is normally set to the Hi-Fi mode, with **L** and **R** displayed on the On Screen Display (OSD), and normal stereo sound output.

Select **L**, and only the Hi-Fi Left channel audio is heard from both the Right and Left speakers.

Select **R**, and only the Hi-Fi Right channel audio is heard from both the Right and Left speakers.

If you select the mono linear track, **L** and **R** will disappear.

NOTE

- Should the Hi-Fi output level be poor, the VCR will automatically select the mono linear track output.
- When playing back tapes which have only Hi-Fi sound recorded: if Hi-Fi sound is not reproduced, or if there is some noise in the audio, press **CHANNEL ▲** or **▼ (CH ▲ or ▼)** until the sound improves.

Adjusting Hi-Fi Audio Tracking

(To adjust the Hi-Fi tracking manually when playing back a poorly recorded Hi-Fi tape)

*Normally you can simultaneously press and hold both **CHANNEL ▲** and **▼ (CH ▲ and ▼)** to obtain the optimal Hi-Fi audio tracking.

- If Hi-Fi audio is unstable (frequent dropouts, etc.) with a rental video, a tape recorded on another VCR, restore normal tracking while playing back the tape as described below:

- 1 Press **MODE OSD** and select the Full Display mode. (See page 11.)
- 2 Simultaneously press **CHANNEL ▲** and **▼ (CH ▲ and ▼)**.
- 3 Press **CHANNEL ▼ (CH ▼)** repeatedly at equal, short intervals until the **L** and **R** indicators disappear from the On Screen Display (OSD).
- 4 Press **CHANNEL ▲ (CH ▲)** in the same manner while counting button operations until the **L** and **R** indicators reappear and then disappear again.
- 5 Press **CHANNEL ▼ (CH ▼)** again for half the number of times counted in step 3 above to obtain optimal tracking.

Recording a TM Programme

Cassette Erase Protection

A **VHS** cassette has a removable tab to prevent accidental erasure of recorded material. Removing the tab prevents recording. To record on a video cassette with the tab removed, place adhesive tape over the tab opening.

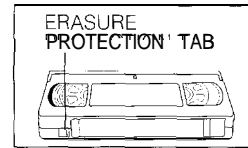

Recording a TV Programme

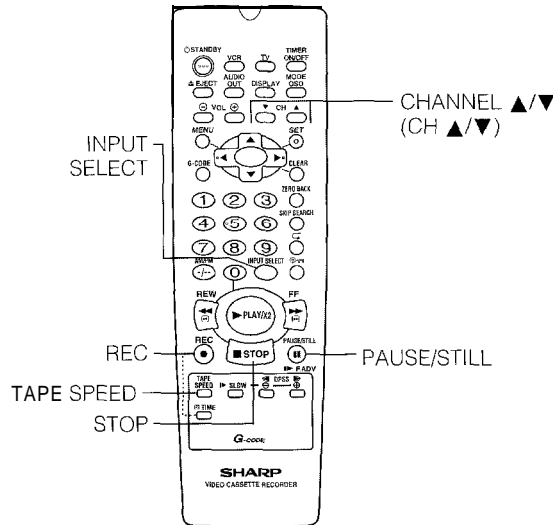
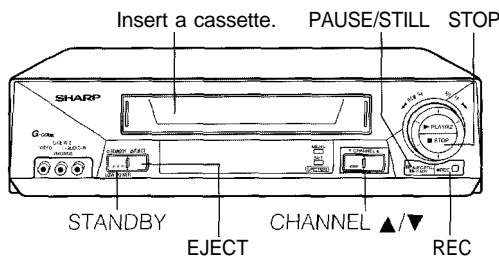

PREPARATION

*Turn on your TV and select the video channel

PROCEDURE

- 1 Turn on the VCR. (See page 5, item 3.)
- 2 Insert the cassette, making sure the erasure protection hole is covered.
- 3 Select the channel position you wish to record with **CHANNEL ▲/▼ (CH ▲/▼)**.
- 4 Select the SP (Standard Play) or LP (Long Play) recording speed with **TAPE SPEED** on the remote control ("SP" or "LP" will light up on the VCR display). SP (Standard Play) gives the best picture quality. LP (Long Play) gives the longest recording time.
- 5 Press **REC**. (If the erasure protection hole is uncovered, the cassette will be ejected.) To pause during recording, press **PAUSE/STILL (F. ADV)**. To resume recording, press **PAUSE/STILL (F. ADV)** again.
- 6 To stop recording, press **STOP**.

NOTE

- The pause mode disengages automatically after about 5 minutes, and the VCR enters stop mode.
- To record audio and video from an external source through the AUDIO/VIDEO terminal on the front or rear of the VCR, press **INPUT SELECT** on the remote control or press **CHANNEL ▲/▼ (CH ▲/▼)** to select the L1 or L2 channel position situated between the last channel and first channel. (When the L1 or L2 position is selected, "L1 or L2" is displayed where a channel position number is usually displayed.)
- If the TV signals are weak and the picture changes to monochrome, set the PAL mode on the MODE selection screen. (See **Colour Mode** on page 20.) Normally, the colour mode should be set to "AUTO".

To Watch Another TV Programme While Recording

After steps 1 to 5 have been completed, select the programme you wish to view using the TV tuner. At the end of the tape, your VCR will automatically stop recording, rewind to the beginning of the tape, eject the tape and turn to the POWER STANDBY mode.



Recording Hi-Fi Stereo Sound

This VCR automatically records audio signals on two kinds of audio tracks.

Hi-Fi: Using specialized rotary heads, audio signals are recorded on the video track in the FM format.

Multi channel broadcasts (stereo or bilingual programmes) are automatically recorded on two tracks.

Normal: Audio signals are recorded monaurally on the linear track. Stereo broadcasts are recorded in mono and only the main audio track of bilingual programmes is recorded.

NOTE

- Video cassettes recorded on a non-Hi-Fi VCR can also be played back. However, if the audio signals are recorded on two linear channels, stereo programmes will be played back monaurally and bilingual programmes will be played back with both the main and sub audio tracks mixed together
- Video cassettes recorded on this VCR can be played back on a non-Hi-Fi VCR. However, only the normal (linear) track will be played back.

Switching Input Signals

Various sources of video and audio signals can be recorded as shown in the following chart.

(a) Selecting a channel will record both video and audio from the VCR tuner.

(b) Selecting an external source position will record both video and audio from an external source via the back-panel AUDIO/VIDEO LINE 1 or front LINE IN 2 terminal. (To select an external source position, press INPUT SELECT or select a channel situated between the last channel and the first channel with CHANNEL ▲/▼ (CH ▲/▼))

Input mode	TV screen	Signals Recorded		
		Video track	Normal audio track	Hi-Fi audio track
T u n e r	2	Signals from tuner		
External 1 (LINE 1)	L1	Signals from AUDIO/VIDEO (LINE1) terminal on the rear of the VCR		
External 2 (LINE 2)	L2	Signals from LINE IN 2 terminal on the front of the VCR		

NOTE

- This VCR can record NTSC signals through AV input terminals

Recording Audio Only

This VCR can record Hi-Fi audio-only signals.

- 1 Connect the audio source (CD player, etc.) to the AUDIO-IN L/R terminals on the front or rear of the VCR.
- 2 Select the connected external position LINE IN 1 or 2 ("L1" or "L2" lights up) by pressing INPUT SELECT or CHANNEL ▲/▼ (CH ▲/▼).
- 3 Press TAPE SPEED on the remote control to select SP or LP mode.
- 4 Press REC.

NTSC AV Recording

Although this VCR does not have a NTSC tuner, NTSC signals can be recorded by connecting a separate NTSC-compatible TV or VCR to the AV input terminals

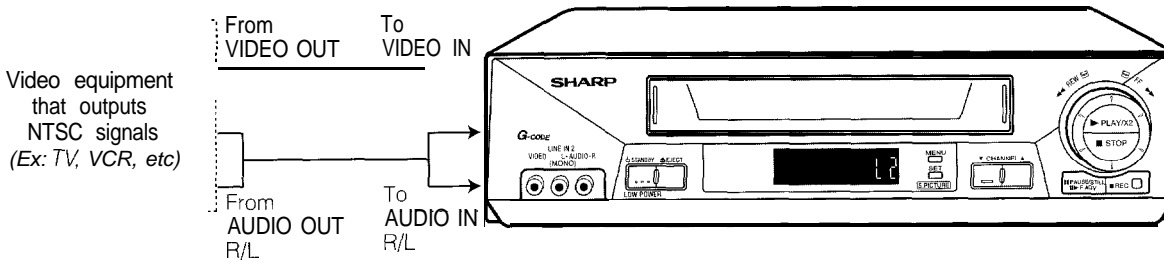

Before recording NTSC signals through the AV input terminals, refer to **Recording a TV Programme** on page 23.

- 1 Select "AUTO" or "NTSC" for the COLOUR mode. (See **Mode Selection** on page 17.)
- 2 Select "3.58" or "4.43" for the NTSC mode according to the input signal type. (See **Mode Selection** on page 17.)
- 3 Select the connected external position LINE IN 1 or 2 ("L1" or "L2" lights up) by pressing **INPUT SELECT**.
- 4 Press **TAPE SPEED** on the remote control to select SP or EP mode.

NOTE

- LP mode cannot be used
- Hi-Fi programmes can only be recorded in SP mode

- 5 Press **REC**.

Simple Recording Timer

There are two ways to use this Simple Recording Timer for your convenience.

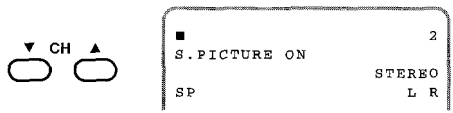
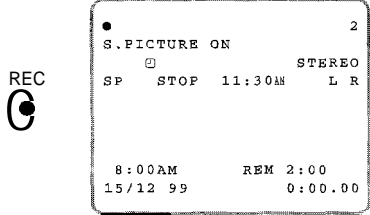

- Immediate recording:
Convenient when having an unexpected visitor or telephone call
- Delayed recording:
Convenient when leaving the house or going to bed.

Immediate Recording

	<p>① Select the channel position to be recorded by pressing CHANNEL ▲/▼ (CH ▲/▼). (Ex.: Channel position: 2)</p>
	<p>② Press REC to enter the normal recording mode. Then, press REC repeatedly to set the desired ending time. (Ex.: Ending time: 11:30 AM)</p> <p>NOTE</p> <ul style="list-style-type: none"> • Each press of REC increases the stop time by 10 minutes.

- NOTE**
- Press STOP to terminate recording

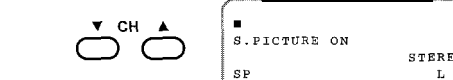
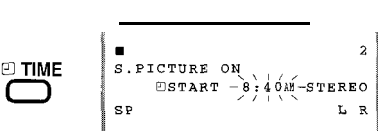
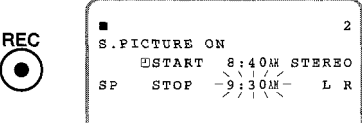
Delayed Recording

	<p>① Select the channel position to be recorded by pressing CHANNEL ▲/▼ (CH ▲/▼). (Ex.: Channel position: 2)</p>
	<p>② Set the starting time by pressing TIME. (Ex.: Starting time: 8:40 AM)</p> <p>NOTE</p> <ul style="list-style-type: none"> • Each press of TIME increases the start time by 10 minutes. *Setting the time within a 24-hour period in 10-minute intervals is possible.
	<p>③ Set the ending time by pressing REC. (Ex.: Ending time: 9:30 AM)</p> <p>NOTE</p> <ul style="list-style-type: none"> • Each press of REC increases the stop time by 10 minutes.
	<p>④ Press STANDBY to turn to the POWER STANDBY mode. (See page 5, item 2.) (Ex.: Present time: 8:28 AM)</p>

- NOTE**
- After the Simple Recording Timer is set, the channel position cannot be changed
 - To confirm the starting time and the ending time, first turn on the power. Then press **TIME** to confirm the starting and ending time. And turn to the POWER STANDBY mode.
 - To clear the Simple Recording Timer setting during setting of "Delayed Recording", press **CLEAR** on the remote control. To clear after setting, turn on the power, press **TIME** to select Simple Recording Timer mode, and then while the **START** time is flashing, press **CLEAR**.
 - The Simple Recording Timer cannot be set if the timer has been preset ("**TIME**" indicator on the VCR display is lit). If this is the case, cancel the timer standby mode by pressing **TIMER ON/OFF**, turn on the power and then proceed with setting of the Simple Recording Timer.
 - Select the SP (Standard Play) or LP (Long Play) recording speed with **TAPE SPEED** on the remote control ("SP" or "LP" will light up on the VCR display). SP (Standard Play) gives the best picture quality LP (Long Play) gives the largest recording time.
 - The stop time for delayed recording must be set within 10 seconds of setting the start time, otherwise start time must be set again.

Programming the Timer with G-CODE®

This VCR has the G-CODE Programming System. By simply inputting the G-CODE number with the 0-9 numeric buttons, you can programme your VCR for timer recording.

The G-CODE numbers are listed in most newspaper, TV guide, and local cable TV listings.

The timer can be set for automatic recording of up to 8 events over a 365-day period. In addition, each of the events can be set to be recorded on a daily or weekly basis up to the limit of the tape.

PREPARATION:

- Select the video channel on your TV. Turn on the VCR. (See page 5, item 3.)
- Load the cassette, ensuring the erasure protection hole is covered. The VCR power will automatically turn on.
- Check that the clock is displaying the correct time.

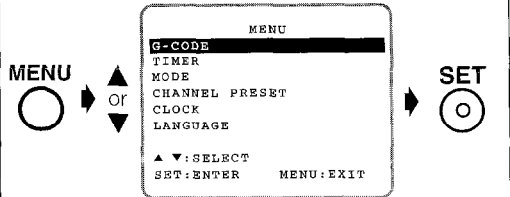
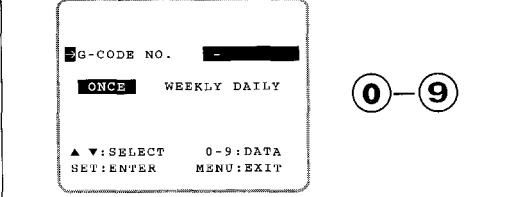
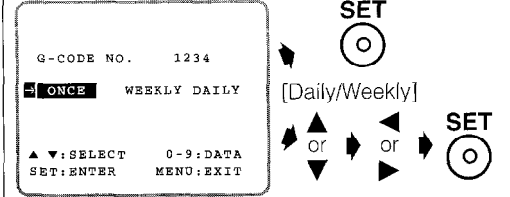
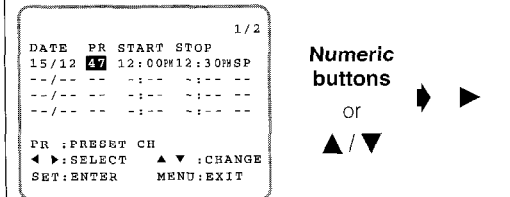
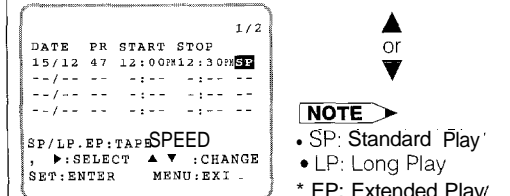
<p>[MENU]</p> 	<p>1 Press MENU.</p> <p>2 Select item "G-CODE" with ▲ or ▼ and then press SET.</p>
<p>[G-CODE]</p> 	<p>3 Set the G-CODE number with the numeric (0 to 9).</p> <p>NOTE</p> <ul style="list-style-type: none"> • For the G-CODE number, refer to your newspaper or TV guide • Press G-CODE to directly select this screen.
<p>[ONCE/DAILY/WEEKLY]</p> 	<p>4 If you want to record only once, press SET and go to step 5. Otherwise, press ▲ or ▼ to select daily/weekly setting mode, and then select "DAILY" or "WEEKLY" by pressing ◀/▶. And then press SET.</p> <p>NOTE</p> <p>"ONCE": To record only once. "DAILY": To record every day at the same time. "WEEKLY": To record every week at the same time.</p>
<p>[Channel]</p> 	<p>5 If you are going to record a programme from a station which does not have the PR number programmed, ("—" is displayed) set that number to be the same as the PR number to which your broadcasting channel is set into. (See Note on the next page.) Use the numeric or ▲/▼. Then press ▶.</p> <p>Ex.: 47</p>
<p>[Tape Speed]</p>  <p>NOTE</p> <ul style="list-style-type: none"> • SP: Standard Play • LP: Long Play * EP: Extended Play (only NTSC Tape) 	<p>6 Select the tape speed with ▲ or ▼. (See Intelligent Timer Recording (JUST REC) on page 32.)</p>

Continued on next page



	<p>7 Press SET.</p> <p>NOTE To programme additional timer settings, press SET and repeat steps 3 through 7.</p>
	<p>8 To return to the normal screen, press MENU</p>
	<p>9 To set the VCR for automatic timer recording, press TIMER ON/OFF and ensure the "□" indication lights on the VCR display.</p>

NOTE

- Please be sure to check that the start and end times of two different programmes do not overlap, as the remote control has been designed to accept the basic individual G-CODE number only. If the recording periods of two programmes overlap, the beginning of the second programme will not be recorded.
- To cancel the programmed G-CODE setting, select the TIMER setting mode on the MENU screen. Then select the programme number you wish to cancel with ▲/▼ and press **CLEAR**. (See **Cancelling Timer Programmes** on page 31)

Setting the Programme Number In Step 5

When using G-CODE for the first time the Programme number (PR) on the screen shows two dashes and is highlighted white. Set it to be the same as the PR number to which your broadcasting channel is set into. For instance, if you can view CH 47 on programme (PR) 47, set the On screen PR number to 47.

- You need to set this only once.
- If the channels are retuned you need to set the PR numbers again.

Input programme No. here

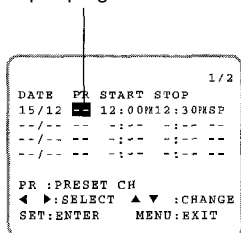

NOTE

- If the wrong programme has been recorded, for future recordings change the PR number (i. e. Step 5) to the same preset channel position number as on the VCR. (Refer to **Manual Tuning** on page 15.)



Recording with the Timer

The timer can be set manually for automatic recording of up to 8 events over a 365 day period.

PREPARATION

- *Select the video channel on your TV. Turn on the VCR (See page 5, item 3).
- Load the cassette, ensuring the erasure protection hole is covered. The VCR power will automatically turn on.
- *Check that the clock is displaying the correct time. (See **Setting the Clock** on page 13.)

PROCEDURE

Example: Recording channel position 47 in SP mode from 12:00 PM to 12:30 PM, December 15, 1999, if the present time is 10:28 (morning), December 14, 1999.

	<p>① Press MENU. Select the TIMER-setting mode and press SET.</p>
	<p>② Select the timer position with ▲/▼ and press SET.</p> <ul style="list-style-type: none"> • If the timer positions 1 to 4 have already been set, the screen changes 2/2 (timer positions 5 to 8).
	<p>③ Set the date for timer recording with the numeric buttons or ▲/▼ on the remote control and then press ▶.</p> <ul style="list-style-type: none"> • First set the "day" digits and then "month". If there is only one "day" or one "month" digit, enter a 0 first.
	<p>④ If you want to record only once, press ▶ and go to step ⑤. Otherwise, select "D (DAILY)" to record at the same time each day or "W (WEEKLY)" to record at the same time each week by pressing ▲ or ▼, and then pressing ▶.</p>
	<p>⑤ Set the channel number using the numeric buttons or ▲/▼ and then press ▶.</p> <p>NOTE ▶</p> <ul style="list-style-type: none"> • To record' audio and' video from an external' source through an AUDIO/VIDEO terminal on the VCR, press ▲/▼ to select an AV' channel. (When an AV position is selected, "L1" or "L2" is displayed where a channel position number is usually displayed.)

- NOTE** ▶
- **▲/▼** can also be used to set the date and time instead of the numeric buttons.
 - Press 0 first if the day, month, hour or minute is a single digit

Continue on next page



Recording with the Timer

<p>Numeric buttons or ▲/▼</p> <p>[Start] R</p> <p>When the clock is set to 24H mode, "AM/PM" will not appear</p> <pre> DATE PR START STOP 1/2 15/12 47 12:00 12:30 SP ---/--- -- --- --- --- ---/--- -- --- --- --- ---/--- -- --- --- --- </pre>	<p>⑥ Set the start time with the numeric buttons or ▲/▼ and press ▶.</p>
<p>Numeric buttons or ▲/▼</p> <p>[Stop]</p> <pre> DATE PR START STOP 1/2 15/12 47 12:00 12:30 SP ---/--- -- --- --- --- ---/--- -- --- --- --- ---/--- -- --- --- --- </pre>	<p>⑦ Set the stop time with the numeric buttons or ▲/▼ and press ▶.</p>
<p>[Tape Speed]</p> <p>A or ▼</p> <pre> DATE PR START STOP 1/2 15/12 47 12:00 12:30 SP ---/--- -- --- --- --- ---/--- -- --- --- --- ---/--- -- --- --- --- </pre> <p>NOTE ▶</p> <ul style="list-style-type: none"> • SP: Standard Play • LP: Long Play • EP: Extended Play (only NTSC Tape) 	<p>⑧ Select the tape speed with ▲ or ▼. (See Intelligent Timer Recording (JUST REC) on page 32.)</p>
<p>[Timer review]</p> <p>SET </p> <pre> DATE PR START STOP 1/2 15/12 47 12:00 12:30 SP ---/--- -- --- --- --- ---/--- -- --- --- --- ---/--- -- --- --- --- </pre> <p>▼▼ 2/2 ▼▼</p> <p>CLEAR: CANCEL ▲▼: SELECT SET: ENTER MENU: EXIT</p>	<p>⑨ Press SET. To programme additional timer settings, repeat steps ③ through ⑧.</p>
<p>MENU </p> <p>Normal Screen</p>	<p>⑩ To return to the normal screen, press MENU.</p>
<p>TIMER ON/OFF </p> <p></p>	<p>⑪ To set the VCR for automatic timer recording, press TIMER ON/OFF and ensure the "☐" indicator lights on the VCR display.</p>

NOTE

- If the video cassette runs out before recording all the programmes, your VCR will stop, eject the cassette, and shut off automatically.
- If power is interrupted for more than 60 minutes (power failure, etc.), all timer settings will be cancelled.
- If **TIMER ON/OFF** is pressed when there is no cassette loaded, "☐" flashes for 5 seconds, indicating that timer recording is not possible.
- If **TIMER ON/OFF** is pressed while a cassette with an uncovered erasure protection hole is loaded, "☐" flashes and the cassette is ejected.
- When "☐" is lit, regular VCR operation, clock setting and setting/cancelling/confirming timer positions are not possible. For regular VCR operation, clock setting and setting/cancelling/confirming timer positions, press **TIMER ON/OFF** to disengage the timer ("☐" disappears), and then turn on your VCR.
- During timer recording, the timer cannot be set.
- To terminate timer recording, press **STOP** during timer recording.
- If the same time is input for the start time and the stop time, the timer setting will be cancelled.



Confirming Timer Programmes

You can see on the On Screen Display a list of all timer programmes that are already set.

PREPARATION

- Turn on your TV and VCR and select the video channel on the TV.

	<p>① Press MENU. (If the “” indicator on the VCR display is lit, cancel the timer standby mode by pressing TIMER ON/OFF and then turn on the power.)</p> <p>② Select the TIMER-setting mode with ▲/▼ and then press SET.</p>
<p>[Example]</p>	<p>③ The screen for confirming programmes that have been set will appear.</p> <ul style="list-style-type: none"> • Check the information displayed. • If you want to correct the data, select the programme to be changed with ▲/▼ and then press SET. Correct the setting as described on pages 29 and 30.
	<p>④ To return to the normal screen, press MENU. *After checking or correcting the programme contents, press TIMER ON/OFF to enter the Timer Standby mode.</p>

Cancelling Timer Programmes

Perform the following procedure to cancel timer programmes that have already been set

PREPARATION

- Turn on your TV and VCR and select the video channel on the TV.

	<p>① Press MENU. (If the “” indicator on the VCR display is lit, cancel the timer standby mode by pressing TIMER ON/OFF and then turn on the power.)</p> <p>② Select the TIMER-setting mode with ▲/▼ and then press SET.</p>
	<p>③ The screen for confirming timer recording programmes that have been set will appear.</p> <ul style="list-style-type: none"> • Select the programme number you wish to cancel with ▲/▼. (The selected programme will appear highlighted.)
	<p>④ Double-check that it is the programme you wish to cancel, and press CLEAR. It will be cleared on the screen.</p>
	<p>⑤ To return to the normal screen, press MENU. • If there are still some programmes set, press TIMER ON/OFF to enter the Timer Standby mode.</p>

Intelligent Timer Recording (JUST REC)

When the tape is expected to run out halfway during timer recording (except for the Simple Recording Timer) in the SP (standard play) mode, the mode will automatically change to the LP (long play) mode to prevent termination of recording.

This function works only when JUST REC mode on the MODE selection screen is set to ON.

For example:

- When a 120-minute programme is timer-recorded with a 90-minute tape while the automatic select is set to LP mode as shown below.

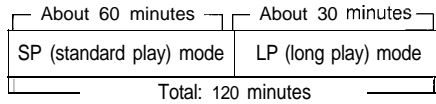

NOTE

- **JUST REC does not function when recording programmes in NTSC mode.**
- This function may not properly work for video tapes other than E-60, E-90, E-180 and E-240.
- This tape may not be completely used up.
- When more than one programme is set on the timer, the automatic recording function will work for the length of each timer-set programme, but not for the total length of all programmes.
- When the LP mode is initially used for timer-recording a programme, if the tape is not long enough to record the entire length of the programme, the programme will not be entirely recorded.

New Sharp Super Picture

This function creates clearer modulation during playback for high picture quality.

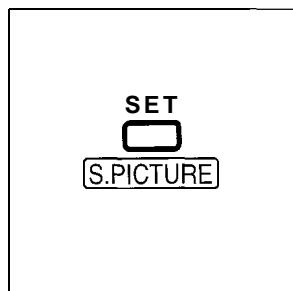

Press **S. PICTURE** on the VCR.

"S.PICTURE ON (or OFF)" will appear on the TV screen for a few seconds. Each time the button is pressed, the mode switches between ON and OFF. (The New Sharp Super Picture is preset to ON at the factory.)

ON:

Normally leave the mode set to ON. This high picture quality function will create a clearer image during playback.

OFF:

Set to OFF when playing back a tape on the VCR while editing or when strong noise appears on the screen. Set to OFF when using the VCR as an editing source.

S.PICTURE ON

NOTE

- This function only operates during playback. It will not operate when recording or watching a TV programme with the VCR tuner
- *This function cannot be set to ON/OFF with the MENU screen displayed.
- If power is interrupted for more than 60 minutes (power failure, etc.), the setting will return to ON.

Zero-Back Function

The zero-back function makes the cassette fast forward (or rewind) to the previously set "0:00.00" point and stop there.

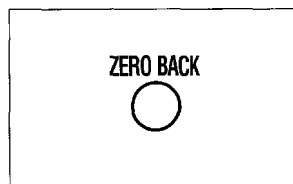

- 1 Make sure the counter is displayed, then press **CLEAR** on the remote control at the point you wish to return to later. "0:00.00" is displayed.
- 2 Press **ZERO BACK** on the remote control. The VCR automatically detects the direction of the "0:00.00" position and fast forwards (or rewinds) the tape.
- 3 When the tape reaches the "0:00.00" position, the tape automatically stops.

NOTE

*The zero-back function does not operate during recording and fast forward (or rewind). The function works during the playback, stop and video search modes.

DPSS (Digital Programme Search System)

With this feature you can quickly locate a desired section of the tape. The DPSS feature makes use of VISS (index) signals to search for a specified tape segment and begin playback automatically.

VISS (index) Signal

An VISS (index) signal is automatically recorded on the tape at the start of ordinary recording, simple recording timer and timer recording.

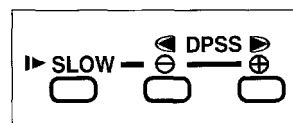
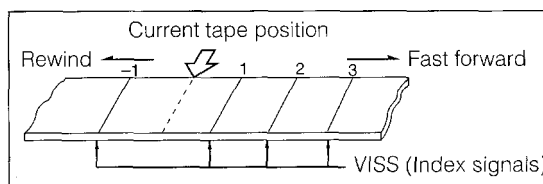

- 1 Load a tape containing VISS (index) signals into the VCR.
- 2 Select the VISS (index) number of the desired programme using **DPSS** or on the remote control. Search starts immediately. (When a signal is located, the displayed number decreases.)
- 3 When the selected VISS (index) signal-encoded section is found, playback begins automatically.

NOTE

- DPSS may not function properly if the VISS (index) signals are too close together (within 5 minutes of each other).
- DPSS can be cancelled by pressing **PLAY/x2** or **STOP**.
- If the tape reaches its end or is rewound completely before locating the desired VISS (index) signal, DPSS is cancelled.
- DPSS may not function for damaged or worn tapes.
- The DPSS function cannot be used with tapes that contain no VISS (index) signals.
- *The starting point of a programme may vary slightly.
- DPSS does not operate during the slow, record, timer standby, and timer recording modes, or when there is no cassette loaded.

Auto Repeat

With this feature, the entire tape is played back repeatedly.

- Set the REPEAT mode on the MODE-selection screen to ON.
When the video cassette reaches its end, the VCR will stop playback, rewind the tape, and automatically play it back again.

COLOUR	AUTO	PAL	NTSC
NTSC	3.58	4.43	PAL TV
BLUE BACK	AUTO	OFF	
AUTO RENTAL	ON	OFF	
REPEAT	ON	OFF	
JUST REC	ON	OFF	

NOTE

- The ON/OFF status of the Auto Repeat can be checked on the MODE Selection screen (See **Mode Selection** on page 17.) (And when the Auto Repeat is ON, "REPEAT" will be displayed on the OSD.)
- If the Auto Repeat is on and the tape is rewound to the beginning with rewind or reverse video search, the tape will automatically start playback.

Skip Search





When SKIP SEARCH on the remote control is pressed during playback mode, the VCR will perform a forward video search for a fixed interval of playback time before resuming playback. Depending on how many times the button is pressed, it is possible to set the forward video search time to approx. 30, 60, 90 or 120 seconds of recorded material.

Number of Times Pressed	Forward Video Search Time	(On the VCR display)
1 time	Approx. 30 sec. (of playback time)	0:30
2 times	Approx. 60 sec. (of playback time)	1:00
3 times	Approx. 90 sec. (of playback time)	1:30
4 times	Approx. 120 sec. (of playback time)	2:00

During skip search, the interval of the video search will flash on the display.

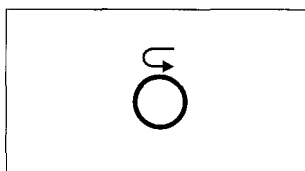
Instant Replay



When  on the remote control is pressed during playback, the VCR will perform a reverse video search for a fixed interval of playback time before resuming playback. Depending on how many times the button is pressed, it is possible to set the reverse video search time to approx. 20, 40, 60, or 80 seconds of recorded material.



New Child-Proof Lock

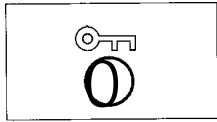

With this feature, you can lock all VCR modes to prevent accidental change. This function works even when the VCR power is off, thus preventing children from operating the VCR or viewing select programmes while you are away from home.

New Child-Proof Lock

- 1 Press on the remote control for about 2 seconds.
“” flashes and “---” lights on the VCR-function display
- 2 Press again.
“” remains lit on the VCR display confirming that New Child-Proof Lock has been activated.
- 3 Now regardless of what other operating buttons are touched, the VCR will continue to operate in the present mode.
(If New Child-Proof Lock is activated during playback, once the tape reaches its end, the VCR automatically rewinds the tape, ejects it, and turns into POWER STANDBY mode.)

Disengaging New Child-Proof Lock

- Press for about 2 seconds.
“” starts flashing and then disappears. Now, New Child-Proof Lock is disengaged.

Advanced New Child-Proof Lock

- 1 Press on the remote control for about 2 seconds.
“” flashes and “---” lights on the VCR display.
- 2 Input the personal code number (4 digit code) with the numbered buttons. The personal code number you have input is displayed on the VCR display.
- 3 Press again.
“” remains lit on the VCR display confirming that New Child-Proof Lock has been activated.
- 4 Now regardless of what other operating buttons are touched, the VCR will continue to operate in the present mode.
(If New Child-Proof Lock is activated during playback, once the tape reaches its end, the VCR automatically rewinds the tape, ejects it, and turns into POWER STANDBY mode.)

Disengaging Advanced New Child-Proof Lock

- 1 Press for about 2 seconds.
“” flashes and “---” lights on the VCR display.
- 2 Input the personal code number (4 digit code) you used to activate Advanced New Child-Proof Lock with the numbered buttons. The personal code number you have input is displayed on the VCR display.
- 3 Press again.
“” disappears. Now, New Child-Proof Lock is disengaged. If the code number is wrong, “---” is displayed on the VCR display. Retry to input the right code number. Press again.

If you forget your personal code number, you can disengage New Child-Proof Lock with the following procedure:

- 1 Press for about 2 seconds.
“” flashes and “---” lights on the VCR display.
- 2 Press **STANDBY** on both the VCR and remote control for at least 2 seconds. New Child-Proof Lock is disengaged

NOTE

- If, while New Child-Proof Lock is on, you attempt to change modes by pressing another button, the “” indicator will flash on the VCR display.

VCR Display

When DISPLAY is pressed, the display changes in the following way. (However, the following is the case when the clock time is set and displayed in the 12-hour system.)

During Playback

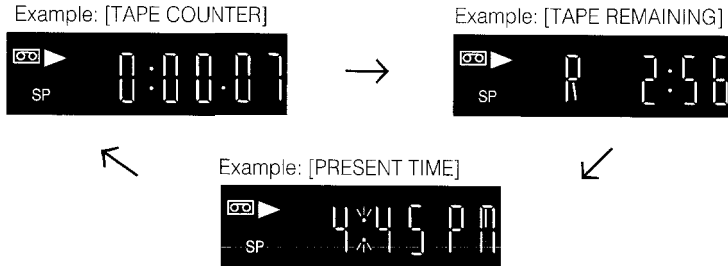

During Recording

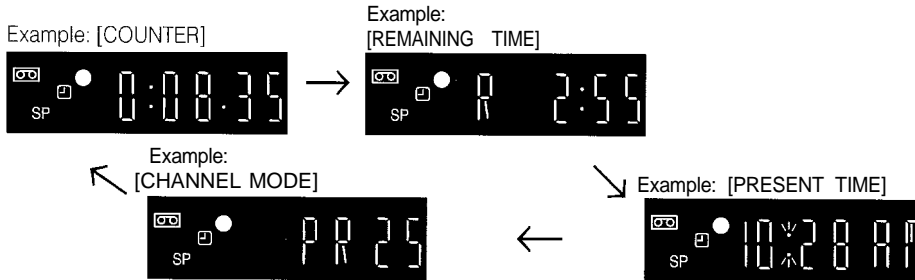

NOTE

- During Simple Recording Timer recording, Recording with the Timer, or Programming the Timer with **G-CODE**® "□" lights.

Counter Clear

Make sure the counter is displayed, then press **CLEAR** on the remote control. "0:00.00" is displayed.



NOTE

- The counter will reset to "0:00.00" when the tape is rewound completely.

Tape Remaining Display

The tape remaining display only works with tapes recorded in PAL. It does not work with tapes recorded in NTSC.

On Screen Display

- Select FULL or COUNTER display mode by pressing **MODE OSD** on the remote control

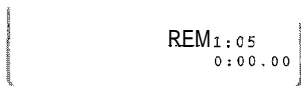

VCR Display

- Press **DISPLAY** on the remote control.



NOTE

- This function accurately displays the tape remaining only for tapes recorded in PAL mode. (It does not accurately display the tape remaining for tapes recorded in NTSC mode.)
- When you insert the tape and the VCR is in the stop mode, the tape remaining cannot be computed. The following indicator is shown when the tape remaining has not yet been computed or cannot be computed

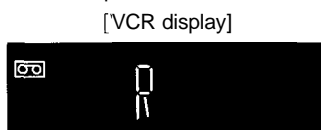

- When you start recording or playback, the VCR will begin the computation. However, this may take some time. When computation is completed, tape remaining will be shown on the OSD and VCR display for 5 seconds.
- If the "REM." mode is selected with **MODE OSD** or **DISPLAY** and the VCR is in stop mode, the tape will automatically fast forward or rewind for a few seconds and then the VCR will *begin computing* the amount of tape remaining.
- During computation, **REC** will not function, and pressing **STOP**, **PLAY/×2**, or other buttons will interrupt the computation.
- Setting the DPSS or ZERO-BACK function during computation may cancel it.
- The indicated length of tape remaining is only an approximate guide.
- This function may not properly work for video tapes other than E-60, E-90, E-180 and E-240.
- The length of tape remaining during fast forward or rewind may be indicated as greater than it actually is.
- When **VHS** and **SVHS** tapes are used with a cassette adapter, the indication may not be correct.

Warning for the length of tape remaining

When the tape reaches the point where only about five minutes of recording time is left, the remaining length of tape will be automatically displayed, as a warning.

NOTE

- No warning, however, will be shown during timer recording or Simple Recording Timer recording



Editing from a Camcorder to Your VCR

Editing from your Camcorder is extremely easy using your VCR with a linear tape counter, etc. The connection diagram below is for a guideline only. Refer to your Camcorder Operation Manual for precise connection information

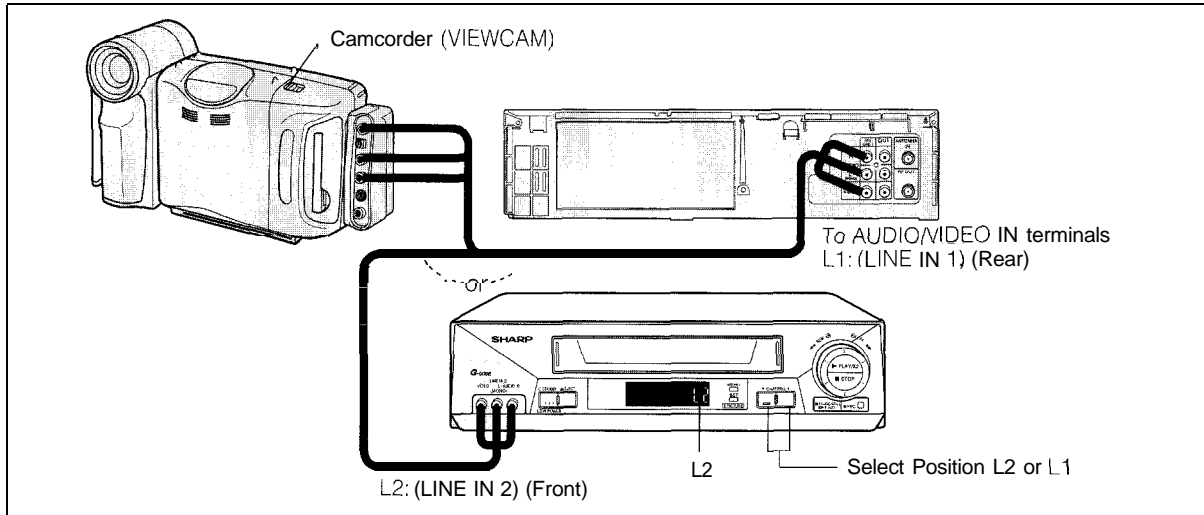

Specifications

- Format: VHS PAL/NTSC standard
- Video recording system: Two rotary heads, helical scan
- Video signal system: PAL/NTSC colour or monochrome (CCIR system B/G) signal
- Hi-Fi audio recording system: Deep-layer recording system conforming to stereo Hi-Fi VHS standard
- Maximum playing time: 480 minutes max. with E-240 tape (PAL)
480 minutes max. with T-160 tape (NTSC)
- Tape width: 12.7 mm
- Tape speed: PAL : 23.39 mm/sec. (SP) 11.70 mm/sec. (LP)
NTSC: 33.35 mm/sec. (SP) , 16.67 mm/sec. (LP: Playback only) ,
11.12mm/sec. (EP)
- Antenna: 75 Ohm unbalanced
- Reception channels: VHF channel 0 to 12, UHF channel 28 to 69
- RF output signal: UHF channel 28 to UHF channel 69 (preset to UHF channel 37)
- Power requirement: AC 240 V, 50 Hz
- Power consumption: 17 W (approx.)/1.0 W Max (at Low Power Mode)
- Operating temperature: 5°C to 40°C
- Storage temperature: - 20°C to 55°C
- Video input: 1.0 Vp-p, 75 Ohm
- output: 1.0 Vp-p, 75 Ohm
- Audio input: (phono type) Line: -8dBs, 47 kohm
- output: (phono type) Line: -8dBs (approx.), 1 kohm
- Hi-Fi audio: Dynamic range: Typically 85 dB
- Frequency response: 20 Hz-20 kHz
- Wow and flutter: less than 0.005% Wrm
- Dimensions: 360 (W) x 256 (D) x 92 (H) mm
- Weight: 3.0 kg
- Supplied accessories: R6 (AA, UM/SUM-3) battery x 2
75-ohm coaxial cable, operation manual, remote control unit

Design and specifications are subject to change without notice.



before Calling for Service

Check this list before calling for service.

Problem	Possible Cause/Solutions
MISCELLANEOUS PROBLEMS	
<ul style="list-style-type: none"> No power. Cannot turn on the VCR 	<ul style="list-style-type: none"> See page 5, item 3. Make sure the power cord is plugged in. Check the outlet, fuse or circuit breaker Press TIMER ON/OFF and disengage the timer.
<ul style="list-style-type: none"> Cassette cannot be ejected 	
<ul style="list-style-type: none"> *The VCR display does not operate properly. 	<ul style="list-style-type: none"> Make sure that the Child-Proof Lock is not engaged. Safety device in VCR is functioning. Unplug the VCR and plug it in again after a few hours, and then set the clock again. Set the timer again if necessary.
<ul style="list-style-type: none"> No operation when any button is pressed. 	
<ul style="list-style-type: none"> VCR does not record. 	<ul style="list-style-type: none"> Cassette's erasure protection tab has been removed. Use a different cassette or place adhesive tape over the tab opening. Check if a cassette is loaded.
<ul style="list-style-type: none"> Cassette is automatically ejected when pressing REC, or TIMER ON/OFF. 	<ul style="list-style-type: none"> *Cassette's erasure protection tab has been removed Use a different cassette or place adhesive tape over the tab opening.
<ul style="list-style-type: none"> No tape movement 	<ul style="list-style-type: none"> Make sure VCR is not in pause/still mode. Make sure tape has not reached the beginning or end.
<ul style="list-style-type: none"> Cassette cannot be loaded. 	<ul style="list-style-type: none"> Make sure there is no other cassette inside. Make sure the cassette is properly positioned and reinsert.
<ul style="list-style-type: none"> Picture does not change even though CHANNEL ▲/▼ (CH ▲/▼) are pressed. 	<ul style="list-style-type: none"> Make sure the VCR is not in the timer setting or clock setting mode Make sure the VCR is not in the channel setting mode.
<ul style="list-style-type: none"> Desired channel position cannot be selected. 	<ul style="list-style-type: none"> *The channel has been set to be skipped. Cancel the skip mode for that channel.
NO COLOUR OR POOR PICTURE	
<ul style="list-style-type: none"> No colour or poor TV picture on normal viewing. 	<ul style="list-style-type: none"> Make sure all the cables are connected properly. Make sure the VCR power cord is properly plugged in.
<ul style="list-style-type: none"> Snowy picture appears on TV during playback. 	<ul style="list-style-type: none"> Adjust CHANNEL ▲/▼ (CH ▲/▼) or try a different cassette. The heads may be 'dirty' from condensed moisture or the magnetic coating of the video tape. (If this is the case, the heads need to be cleaned. Ask the retailer or Sharp approved service centre.)
<ul style="list-style-type: none"> No picture appears or colour is not correct during playback. 	<ul style="list-style-type: none"> Check all connecting cables.
REMOTE CONTROL PROBLEM	
<ul style="list-style-type: none"> *The VCR cannot be operated by the remote control. 	<ul style="list-style-type: none"> The remote control unit is too far away from the main unit. The remote control unit is not pointed correctly at the photoreceptor window. The batteries are exhausted. The batteries have not been inserted in the correct direction (+/- polarity).



This unit is equipped with a microprocessor. Its performance could be adversely affected by external electrical noise or interference. If this should happen, unplug the VCR and plug it in again after a few hours.